



HIDELS PUMP

High Performance Self-Priming Engine Pump

OPERATION MANUAL

Common points for all series

- Thank you for choosing Koshin Hidels Pump.
- This manual is prepared for your safety when operating pump. Please read carefully and comprehend fully before use. (Wrong usage could cause injury or death.)
- Please keep this manual handy for future reference.

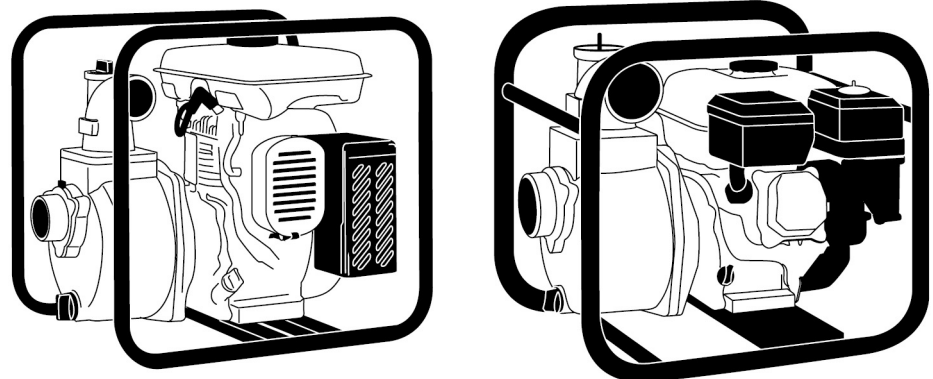
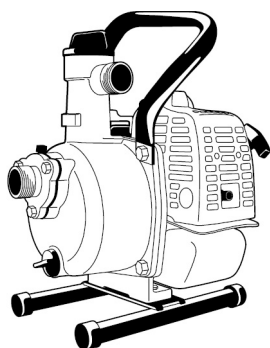

KOSHIN LTD. <http://www.koshinpump.com>

12 Kami-Hachinotsubo Kotari, Nagaokakyo City, Kyoto 617-8511 JAPAN
TEL.+81-75-954-6111 FAX.+81-75-954-6119

05-09 012047401tx

CAUTION

1. Application

As this pump is design for agriculture use, do not apply with muddy water.

- * Trouble if you don't observe.
Could damage mechanical seal.

2. Priming

As this pump is self-priming type, fill water fully into priming port before running.

- * Trouble if you don't observe. Impossible to start pumping and may damage mechanical seal.

3. Connection of suction hose

If pump does not work after filling water into priming port, it is likely due to poor connection of suction hose. In such case, check hose connection again before starting pump.

- * Trouble if you don't observe. Impossible to pump.

4. Engine oil

Fill engine oil into oiling port, shown in illustration, at the bottom of engine. Change oil every 8 hours for the first 20 hours and every 50 hours thereafter.

Applied oil : SAE#30 (spring-summer),
SAE#20 (autumn-winter),
SAE10W-30 (cold district, below-10°C)

- * Trouble if you don't observe.
Burning of engine.

5. Drain water after use

Water inside may freeze at below 0°C in winter and may damage pump. After use, drain water from drain plug before storing.

- * Trouble if you don't observe. Breakage of pump casing.

6. Long storage

Discharge fuel from fuel tank and carburetor completely.

- * Trouble if you don't observe. Impossible to start engine in future. (Engine details, refer Engine Operation Manual.)

7. Prevent water hammer

Do not abruptly compress discharge hose during operation.

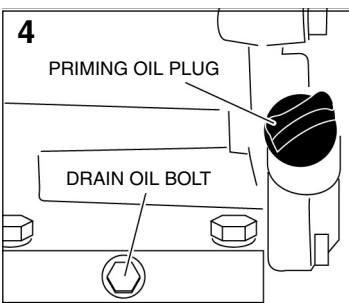
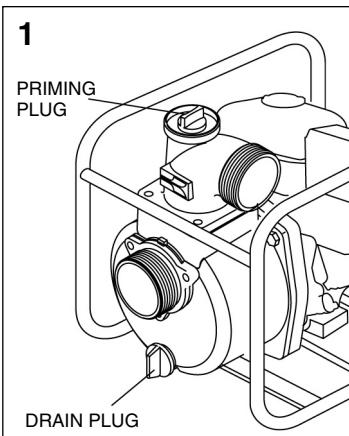

SAFETY PRECAUTIONS

Read this "Safety Precautions" before operation.

Below information should not be neglected for proper use of this product. Your understanding can prevent harm or danger to user or others.

Following information is very important for safety in handling this product. Be sure to observe them.

	DANGER	Indicates an imminently hazardous situation which, if not avoided, will result in death or serious injury.
	WARNING	Indicates a potentially hazardous situation which, if not avoided, could result in death or serious injury.
	CAUTION	Indicates a potentially hazardous situation which, if not avoided, may result in minor or moderate injury, or property damage.
IMPORTANT	PROHIBITED ALERT	

DANGER

	Avoid fire when refuel or maintenance. Highly inflammable!
	Do not operate Hidels pump inside a room or under bad ventilation condition. Harmful substances are in exhaust gas. There is danger of gas poisoning.
	In case of operating Hidels Pump in a well or in a hollow, the person operating the pump must not enter the small space as there is danger of gas poisoning.
	Do not use pump on slope. Fuel spillage at tank cap or carburetor may cause fire.
	Do not put any obstacle around engine muffler. It may cause fire or breakage.
	Read carefully and understand fully before use.
	Keep children away from pump when in operation.
	Do not overhaul or repair, except by person who is trained to do so.

CAUTION

	Do not touch muffler or any part of the engine. It could cause burn.
	Use this pump for clean water or agriculture water. Not Suitable: drinking water, mud water, seawater, kerosene, light oil, heavy oil, gasoline, chemical, acid, alkaline etc.
	Use correct type of suction hose. Water temperature tolerance: 5 to 45°C. May cause breakage if use outside the mentioned range.
	Please don't run pump without water inside the pump. This will cause pump damage.
	Please use suction hose for suction side. Please purchase suitable hose to fit to connection dia and suitable length.
	Please firmly connect hose with coupling and hose band when you connect suction or delivery hose to pump.
	LABEL Replace name plate if damaged/peeled, please order with sales store.

BEFORE USE

1 Check accessories provided

List of accessories provided are printed on the pump manual.

2 Fuel / Engine oil 2-stroke engine

Please use "**Unleaded gasoline mixed with lubricant**" only.

*Please use "**2-stroke oil**" only.

Mixing Ratio **25** (Unleaded gasoline) : **1** (2-stroke oil)

	WARNING Inflammable!! Avoid fire when refuel or maintenance.
	Inflammable! Do not smoke when mixing fuel and refuel near open fire. Any fuel spillage must be cleaned completely before starting the engine.
	CAUTION Stop engine and wait until the engine has cooled down before refueling. Do not use old fuel over 30 days. Fuel should be clean and fresh. Fuel around the bottom of drum contains dirt, impurities and water. Unused fuel in tank (if kept more than 30 days) may cause engine failure.

4-stroke engine

4-stroke engine needs **"engine oil"**

There is **no engine oil in the engine**. Before starting engine, engine oil must be filled. If you start engine without engine oil, engine will burn out and it is difficult to repair. (Warranty does not cover such claim.)

Please use **"Non-Lead Gasoline for Automobile"**.

! WARNING Inflammable!! Avoid fire when refuel or maintenance.

! CAUTION Before starting engine, please check if engine oil is filled to required level. Without engine oil or shortage of engine oil can cause troubles for engine.
Please read carefully Engine Operation Manual for engine oil instructions.
Inflammable! Do not operate near open fire.
Any fuel spillage must be cleaned completely.
Check engine oil before operation. Check and refuel periodically. Please read Engine Operation Manual for instructions.
Stop engine operation when refuel engine oil.
Engine oil can be very hot after operation.

3 How to install Coupling

! CAUTION Different accessories are suitable for different models. Please check connection diameter and install correct parts.

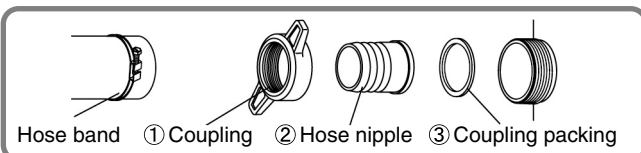

! CAUTION Please install coupling in order of : ①⇒②⇒③
If you install coupling packing not in above order, air leakage may result, affecting water suction efficiency.
Do not change pump diameter by altering suction hose.

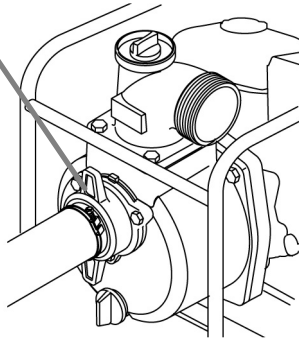
**4 Make sure suction hose is connected properly**

In case of no self-priming after filling pump with water and engine is started, check suction hose connection carefully again.
Most cases of no self-priming are caused by improper hose connection.

! CAUTION Use suction hose for suction side. Use couplings/hose band as provided in accessory and attach hose properly. Installation of strainer at the end of suction hose is necessary.

5 Fill pump with water before use

As pump is self-priming type, fill water fully from priming port into pump before running. Insufficient water can cause damage to pump.

! CAUTION Running without filling water can damage mechanical seal.

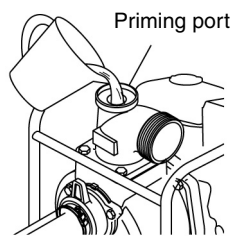
**HOW TO USE**

- 1 Ensure pump is fully filled up with water.
- 2 Ensure strainer at the end of suction hose is in water. (If any mud or sand is at the bottom of water, suspend hose avoiding the bottom.)
- 3 Ensure no obstacle is at delivery hose side.

! CAUTION **Beware of water hammering**
Do not allow any vehicle to run over the delivery hose. Do not close the delivery valve abruptly because water-hammer may occur. This may result in heavy damage to the pump.
For engine manual and notes, please refer Engine Operation Manual enclosed.

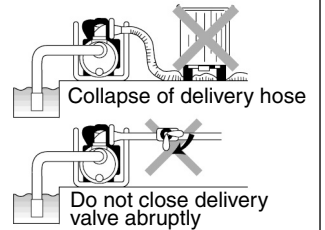
**ATTENTION AFTER USE**

- 1 Drain water after use.

! CAUTION Water inside may freeze at below 0°C in winter and may damage pump. After use, drain water from drain plug before storing.

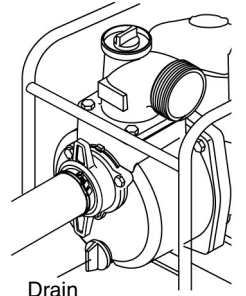

- 2 Long storage

Discharge fuel in fuel tank and carburetor completely. Unused fuel in tank (if kept more than 30 days) may cause engine failure.
*Please refer Engine Operation Manual.

! CAUTION Do not smoke as fuel is highly inflammable.
Unused fuel must not remain in the tank for long term storage. Unused fuel may cause future engine failure.

TROUBLESHOOTING GUIDE

PROBLEM	POSSIBLE CAUSE	SOLUTION
Cannot pull or hard to pull recoil starter	Old fuel	Replace to new fuel. If there is no improvement, repair engine.
	Rusting inside engine	Refer to Engine Operation Manual. (Repair)
	Burn out of engine	Refer to Engine Operation Manual. (Repair)
	Stick impeller	Dismantle & clean the impeller ⇒ SOLUTION ①
Not enough delivery volume	Obstacles at impeller	⇒ SOLUTION ①
	Air leakage from suction side	Check piping at suction side ⇒ SOLUTION ②
	Output power down from engine	Check & Repair engine
	Damage of mechanical seal	Replace mechanical seal (Repair)
	Suction lift is high	Make suction lift lower
	Suction pipe is too long or smaller in diameter	Shorten suction pipe or enlarge diameter.
	Leakage of water from delivery hose or pipe	Check and stop leakage of water.
Pump does not prime water	Obstacles at impeller	Dismantle & clean the impeller ⇒ SOLUTION ①
	Wearing out of impeller	Replace the impeller (Repair)
	Air goes in from suction side	Check piping at suction side ⇒ SOLUTION ②
	Insufficient priming water inside pump casing	Pour more water into pump casing for priming. Refer [BEFORE USE] "5 Fill pump with water before use"
	Drain plug is not tighten	Tighten drain plug firmly. Please refer "ATTENTION AFTER USE"
Engine does not start.	Imperfect revolution of engine	Refer to Engine Operation Manual.
	Damage of mechanical seal (NOTE)	Replace mechanical seal (Repair)
	Wrong suction hose used	Use suction hose correctly
	Carburetor is choked	Repair
	Spark Plug is wet	Check & repair the plug ⇒ SOLUTION ③
	Air cleaner dirty	Clean air cleaner. (Refer to Engine Operation Manual.)
	Too much engine oil (4-cycle engine)	Adjust engine oil to suitable level.
	Insufficient engine oil (4-stroke engine)	Function of oil alert (oil sensor) is working. (This function protects engine. If volume of engine oil is not suitable level, engine does not start.)
	Even if you check above points, still engine does not start.	Possibility of damage, inner parts of engine (Repair)
	Oil leakage form muffler or air cleaner	Fall of engine. Repair

SOLUTION ①

Remove obstacle in impeller. (Please don't remove impeller)

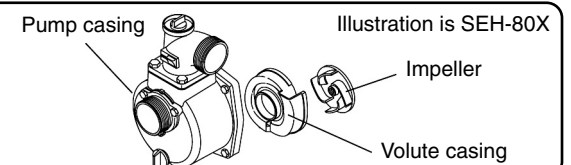
**SOLUTION ②**

Check suction pipe.

In case of no suction or small delivery, the cause is usually due to air leakage at suction side.

In such case :

- ① Remove suction hose
- ② Start engine with water inside the pump.
- ③ Press the palm of your hand to cover the suction hole and wait 30 seconds. If you feel suction on your palm, the pump is working fine but hose connection needs correction.
- ④ Please check if rubber packing is installed and if there is any hole on suction hose.

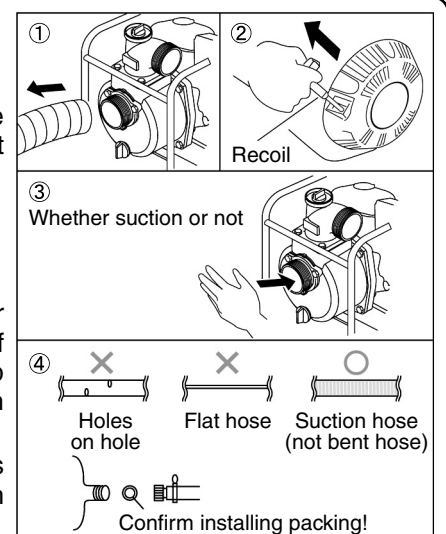
**SOLUTION ③**

Confirm spark plug if wet or stained.

Please clean plug with cloth if spark plug is wet or stained.



Confirm gap between spark plug.

Plug gap should be 0.6–0.7mm. Adjust gap to be within this range.

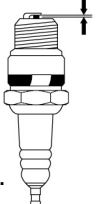

- New spark plug may be required, if engine cannot start even after you clean plug or adjust gap of plug.

! CAUTION There are many different types of spark plugs. Please check and select correct plugs according to Engine Operation Manual.

NOTE

In case of water leakage between engine and pump, usually the cause is damaged mechanical seal. Please ask shop for assistance and replace mechanical seal.

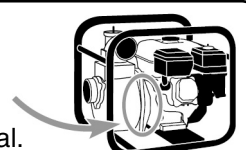

! CAUTION For check assistance and repair, please ask your nearest sales store for after sales service.